



DDR3 SDRAM UNBUFFERED MINI-DIMM MODULE, 1.5V 1GByte - 128MX72 ECC AVG7228U61F7066G0-AP

FEATURES

JEDEC DDR3 PC3-8500 1066MT/s, Lead Free, RoHS compliant

- Clock frequency: 533MHz with CAS latency 7
- 256 byte serial EEPROM
- Data input and output masking
- Programmable Partial Array Self-Refresh (PASR)
- Programmable Output driver impedance control
- Programmable CAS latency: 7
- Burst lengths (BL): 8 and 4 with Burst Chop (BC)
- Bi-directional Differential Data-Strobe
- Gold card edge fingers
- 8K refresh per 64ms
- Low active and standby current consumption
- On Die Termination (ODT)
- Auto refresh and self refresh capability
- Double-sided module
- 18.30mm (0.72 inch) height

DESCRIPTION

The AVG7228U61F7066G0-AP is an Unbuffered DDR3 SDRAM mini-DIMM module. This module is JEDEC Pinout compatible DDR3 SDRAM Unbuffered mini-DIMM. A 256 byte serial EEPROM on board can be used to store module information such as timing, configuration, density, etc.

The AVG7228U61F7066G0-AP memory module is 1GByte and organized as 128MX72 ECC array using (9) 128MX8 DDR3 SDRAMs in lead-free FBGA packages.

The module PCB is fabricated using the latest technology design, ten-layer printed circuit board substrate construction with low ESR decoupling capacitors on-board for high reliability and low noise.

PHYSICAL DIMENSIONS

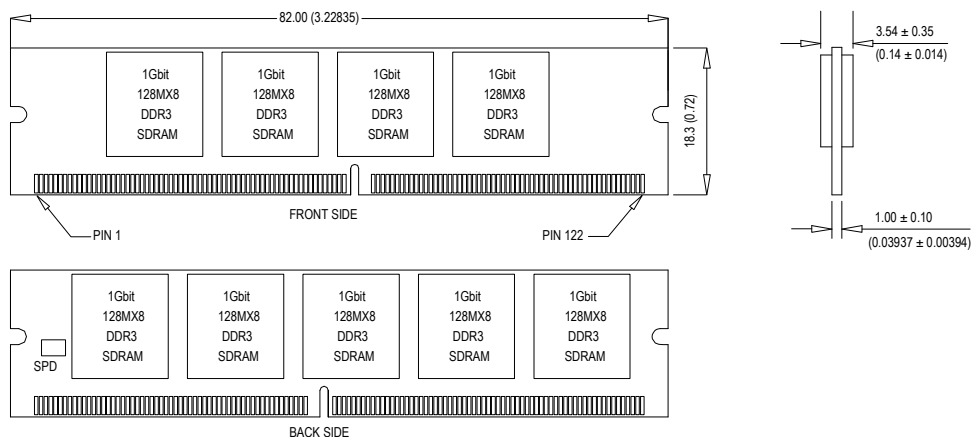

NOTES: 1- All dimensions are in millimeters (inches)
2- The dimensional drawings are for reference only. Refer to the JEDEC document for additional information.

Avant Ordering Guides

INVENTORY	MOD. TYPE	ORG.	DENSITY	PARITY	TYPE	VOLT.	FEATURE	SPEED	MODE	REV
AV = AVANT	G = 244 PIN MINI-DIMM	72 = X72	28 = 128M	U=UNBUFFERED	61 = 16Mx8x8 (DDR3 SDRAM)	F = 1.5V	7 = CAS LATENCY 7	1066MT/s	G = DDR3 SDRAM	DEFAULT

Other options may be available. Call for specific part number information on options not listed.



Avant™ Technology LP., reserves the right to change products or specifications without notice.